

From Eye to Insight

Leica

MICROSYSTEMS

POWERFUL UPRIGHT MICROSCOPE SOLUTIONS FOR LIFE SCIENCE AND CLINICAL APPLICATIONS

Leica DM4 B

Leica DM6 B



SHORT TRAINING TIME, INTUITIVE USAGE AND HIGH QUALITY IMAGES ARE DECISIVE CRITERIA WHEN CHOOSING AN UPRIGHT RESEARCH MICROSCOPE.

I NEED A QUICK ORIENTATION ON THE SAMPLE RIGHT FROM THE START TO SAVE VALUABLE TIME.

Dr. Andreas Vonderheit
Director of Core Facilities and Technology,
IMB Mainz (Germany)



Simplify your workflow

The Leica DM4 B and DM6 B utilize intelligent automation and integrated work flow based software to provide users an easy-to-use imaging system that is suitable for individual or multi-user laboratories.

Speed up your application performance

Time is short. Speed up with our next generation of upright microscopes. The ability to effectively use larger camera chips effectively plus our LAS X Navigator tool for faster orientation on your sample saves valuable time during research.

Stay ahead with flexibility

The Leica DM4 B and DM6 B allows you to build the microscope that fits your need and budget. Whether selecting LED illumination, contrast techniques, or automation you are able optimize your imaging system to your application.





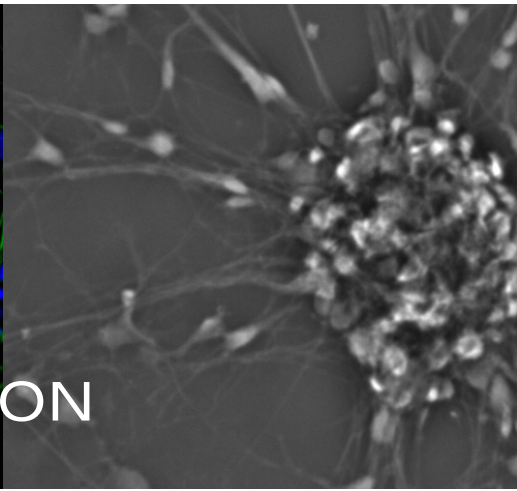

MAKE YOUR LIFE EASIER WITH INTELLIGENT AUTOMATION

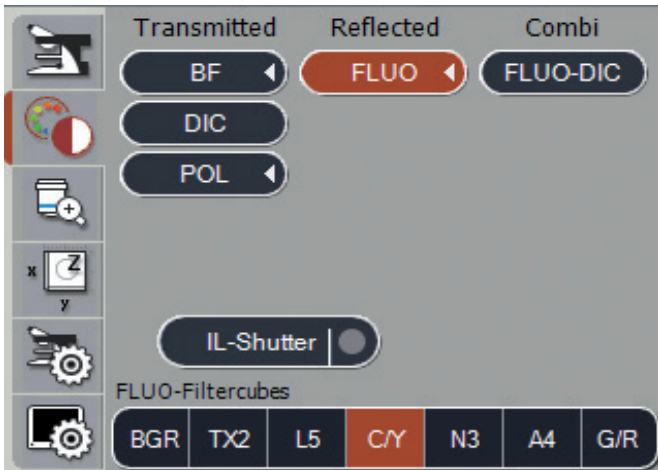

Quickly change contrast methods with the press of a button

The Contrast Manager provides users with the ability to change contrast methods with just the push of a button. All necessary adjustments, including prisms and phase contrast rings, are automated. This allows you to focus on your experiment, and not have to worry about your microscope.

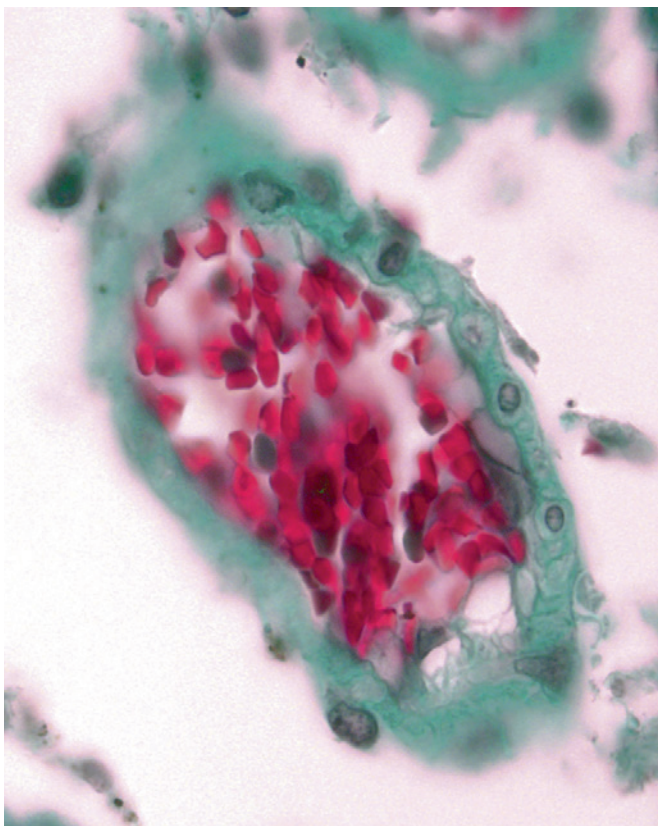

Save time with automatic Koehler light management

Automated Koehler light management ensures that your images are publication ready – everytime. Simply place the specimen on the microscope stage, focus, and it is ready to be viewed. The Leica upright microscope detects the selected objective in use, automatically adjusts the condenser head, aperture, and field diaphragm, and adjusts the light intensity. You can alter these values at any time. Modified settings are automatically stored and imported as the microscope's new default values.

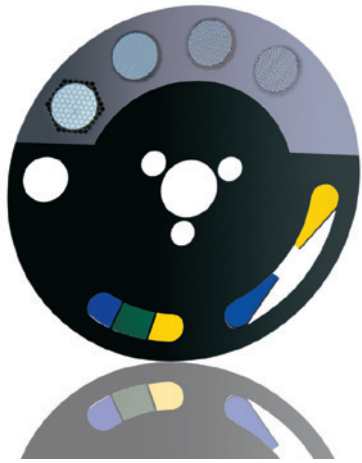
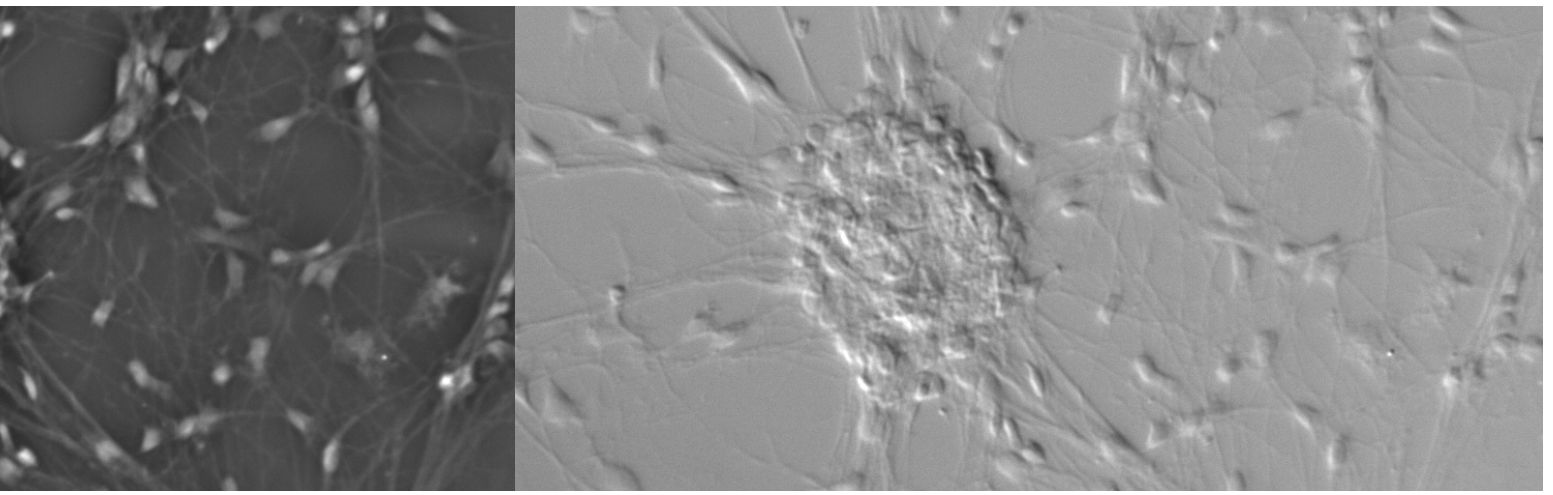

Constant color temperature ensures optimal publication quality images

LED illumination provides constant color temperature at all light intensity levels.

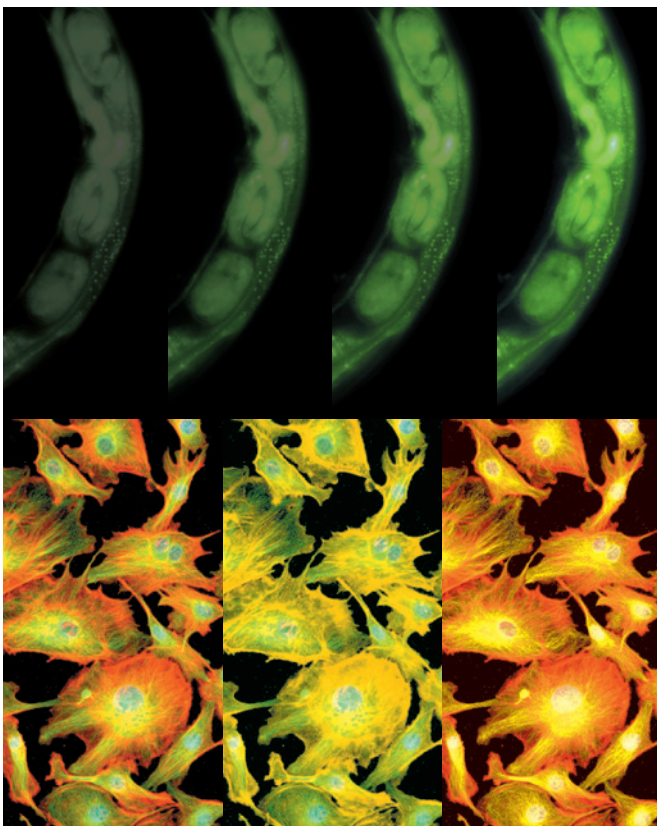

Acquire fluorescence images with ease

Intelligent Automation not only simplifies transmitted light techniques, but also fluorescence imaging.

The Fluorescence Intensity Manager (FIM) provides fast and reproducible regulation of the excitation light to effectively protect the specimen from photo bleaching.

The Excitation Manager is used to balance fluorescence when viewing multiple fluorophores simultaneously. The intensity of different wavelengths can be adjusted, and the fine coding ensures reproducible results. The fast Internal Filter Wheel (IFW) controls single excitation channels when using a dual or triple fluorescence cube. This allows very fast switching between different wave lengths.

COMFORTABLE CONTROL AND ERGONOMICS



Capture images with comfort

Leica Microsystems' adaptable, ergonomic tubes can be adjusted perfectly to your seated height and posture. The adaptable stage for right or left handed people makes simultaneous focus and movement control easy and promotes a relaxed body position – even after hours of work at the microscope.

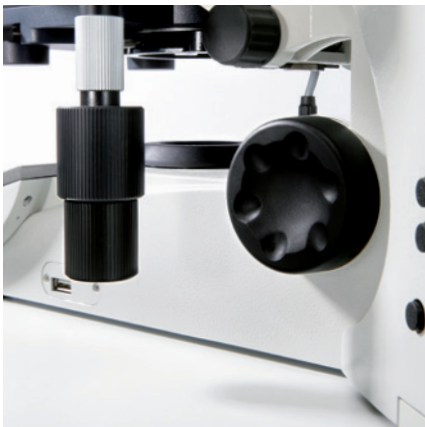



Teach the microscope your favorite functions

Users can assign microscope functions to the function buttons. Program these easily accessible buttons to perform any desired function. Additional programmable function buttons are located on the external Leica STP8000 SmartTouch Panel control or on the Leica SmartMove remote control.

Control the microscope from any position

The Leica STP8000 SmartTouch Panel can be used to control the microscope from any position at the laboratory workstation. All automated functions can be set intuitively from the external control panel. The SmartTouch Panel also offers a focus wheel for fine and coarse adjustment, controls for x,y stage adjustments, and eleven programmable function buttons.



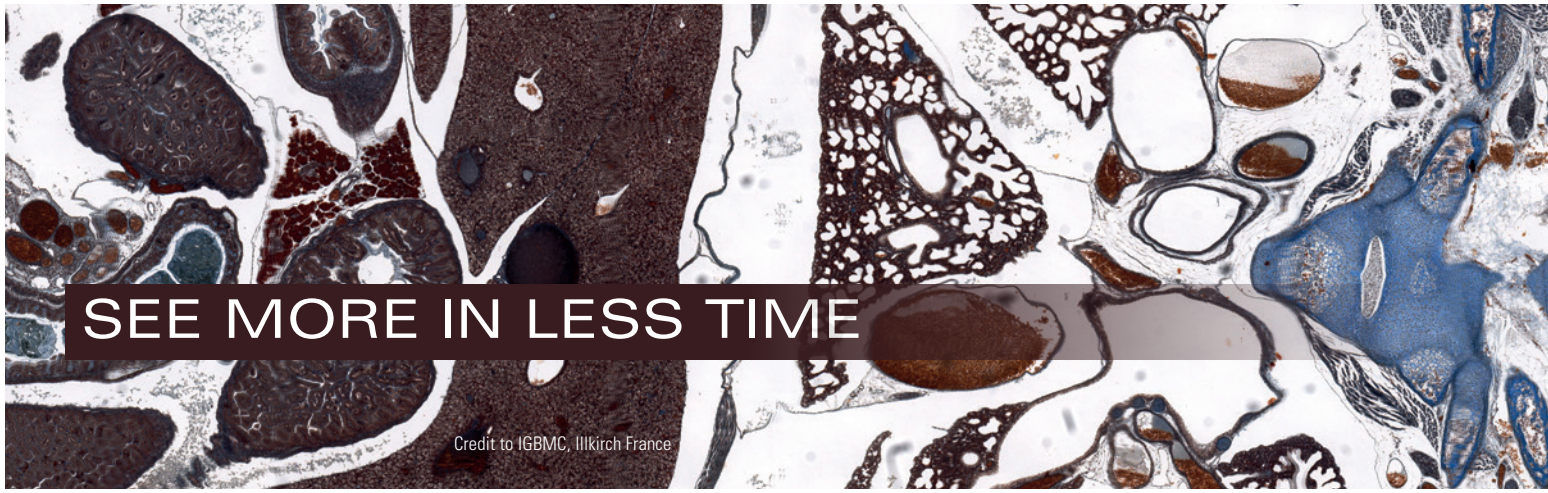

SEE MORE IN LESS TIME

Credit to IGBMC, Illkirch France

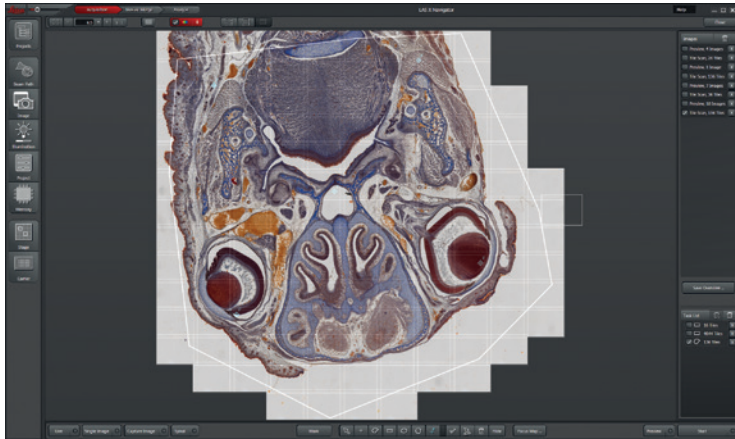

LAS X for best results

The Leica Application Suite X (LAS X) software is the easy-to-use software platform for life science research for Leica Microsystems' widefield, stereo, confocal and super resolution systems. It provides users with a powerful imaging tool in an accessible workflow based design.



LAS X Navigator

The latest addition to LAS X software is the LAS X Navigator, a key to all applications on Leica upright microscopes with motorized or scanning stages.

See up to 10.000x more of your sample with LAS X Navigator

Switch from searching image by image to seeing the full overview of your samples. Like a GPS for your cells, LAS X Navigator ensures that you always have a clear roadmap to brilliant data. Create fast overviews of your samples and identify the important details instantly. Then set up high resolution image acquisition automatically using templates for slides, dishes and multiwell plates.

Tuned to your application – Use custom templates for different numbers and sizes of slides, like four or eight slides, petri dishes and multi well plates.

See more with your sCMOS camera

The Leica DM4 and DM6 is designed for sCMOS cameras by featuring a new 19 mm field of view camera port. This perfectly fits to the dimensions of common sCMOS sensors. Make your slide examination faster at the highest resolution!

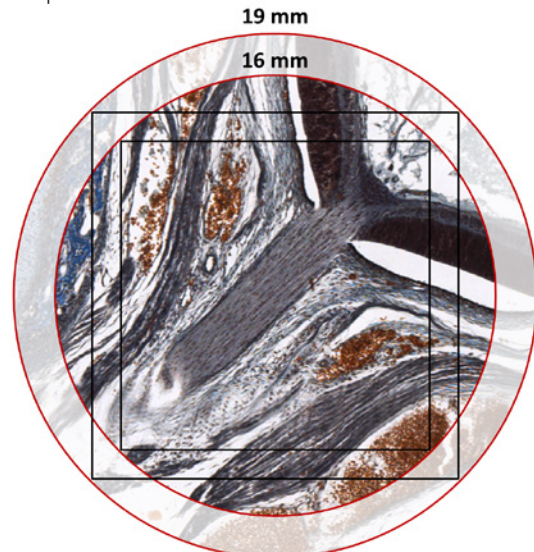

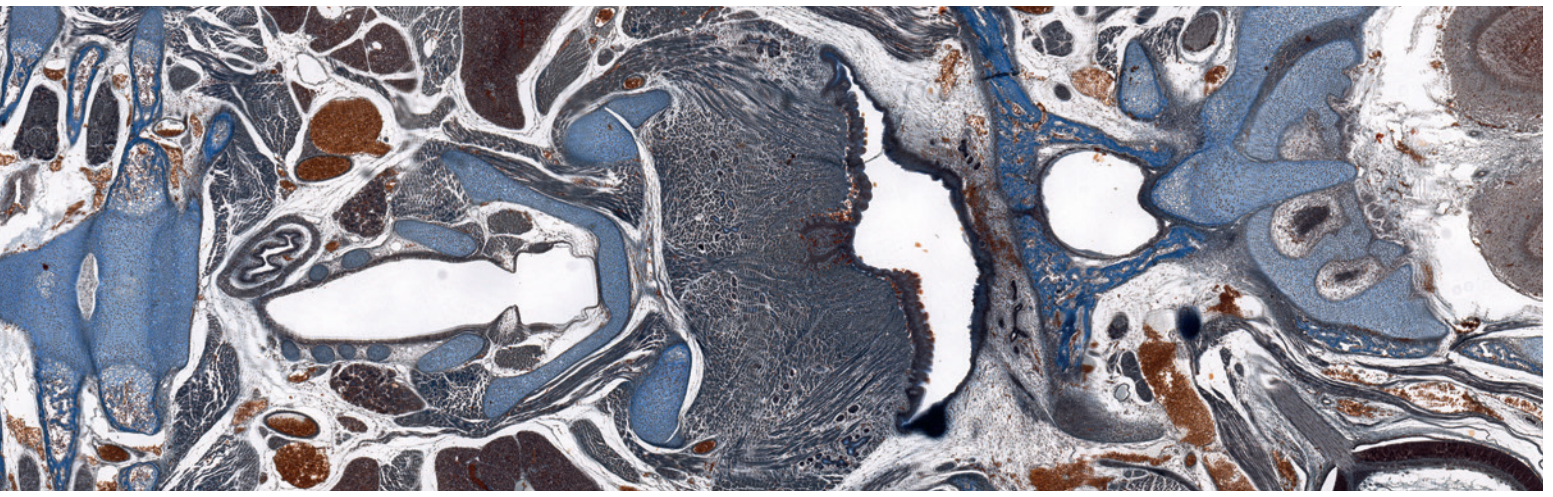

Motorized field diaphragm for the best imaging results

The motorized field diaphragm level features six round and square field stops of various sizes. When using a digital camera, the square field stops best match the image section to the chip size of the camera. This prevents bleaching of prepared sections that have not yet been imaged and improves the signal-to-noise ratio.

Benefit from our brilliant objective portfolio

High performance optics is the key for amazing results in microscopy. Find the objective perfect for your application and choose from our broad selection.





SYSTEM INTEGRATION FOR YOUR APPLICATIONS

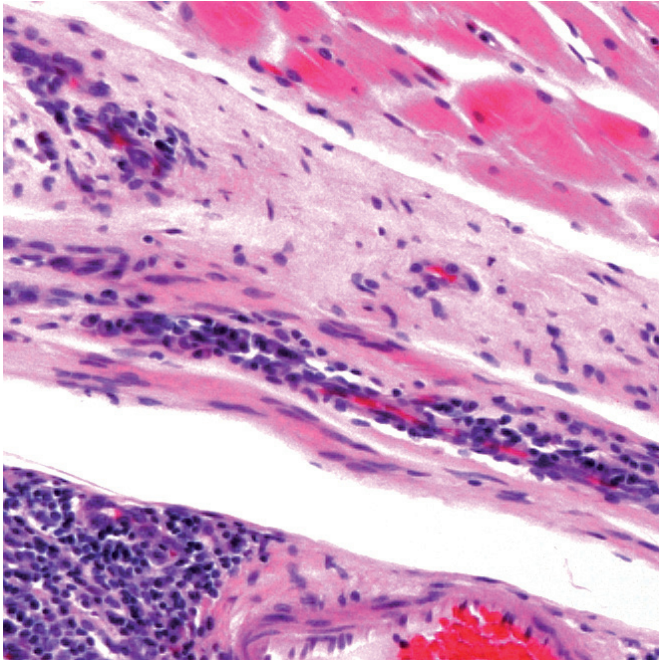

Flexible illumination configuration

If incident illumination is not necessary, the Leica DM4 and Leica DM6 can be configured without a fluorescence axis, making the system more cost effective.

The advantages of LED illumination

Transmitted light LED illumination provides constant color temperature at all light intensity levels for reliable results. With at least 25,000 hours lifetime, the LED illumination is very cost effective, as frequent bulb exchanges are no longer necessary.

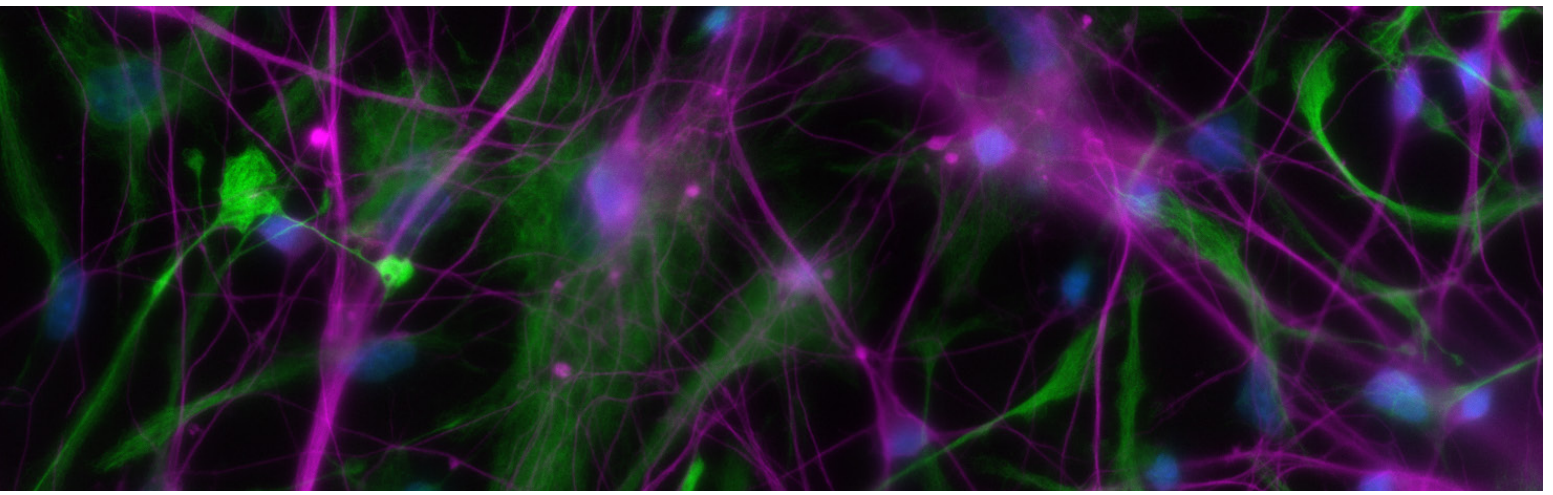

Software seamlessly integrates the entire microscope system

An integrated imaging system gives the best results if all components seamlessly work together. Leica Microsystems offers a complete imaging system from one source: microscope, camera, and software – customized and perfectly matched to work together.

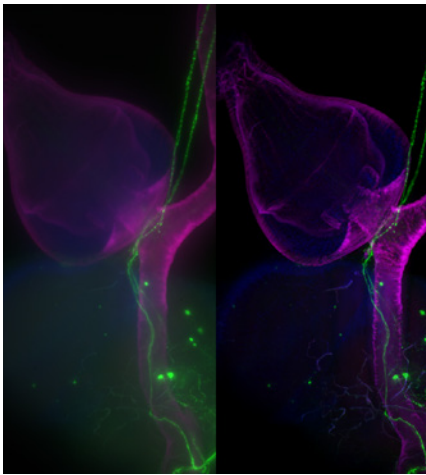

Drosophila, neuroendocrine cells (GFP), actin filaments (Phalloidin)

Courtesy of
 Dr. Satoru Kobayashi, University of Tsukuba, Japan
 Dr. Yuya Ohhara, Dr. Kimiko Kobayashi, University of Shizuoka, Japan

Left: Original
 Right: Deconvolved image

Digital cameras for every requirement

The new Leica upright microscopes provide the ideal imaging solution for every application. You can choose from Leica Microsystems, portfolio or 3rd party cameras. The range of options extends from color or black and white imaging for medical and biological applications up to longer recordings with several minutes of exposure time for fluorescence microscopy with low light intensity. The enlarged Field of View (FOV) also supports efficient usage of highly sensitive, high speed, and larger format sCMOS sensors to capture greater details than ever before.



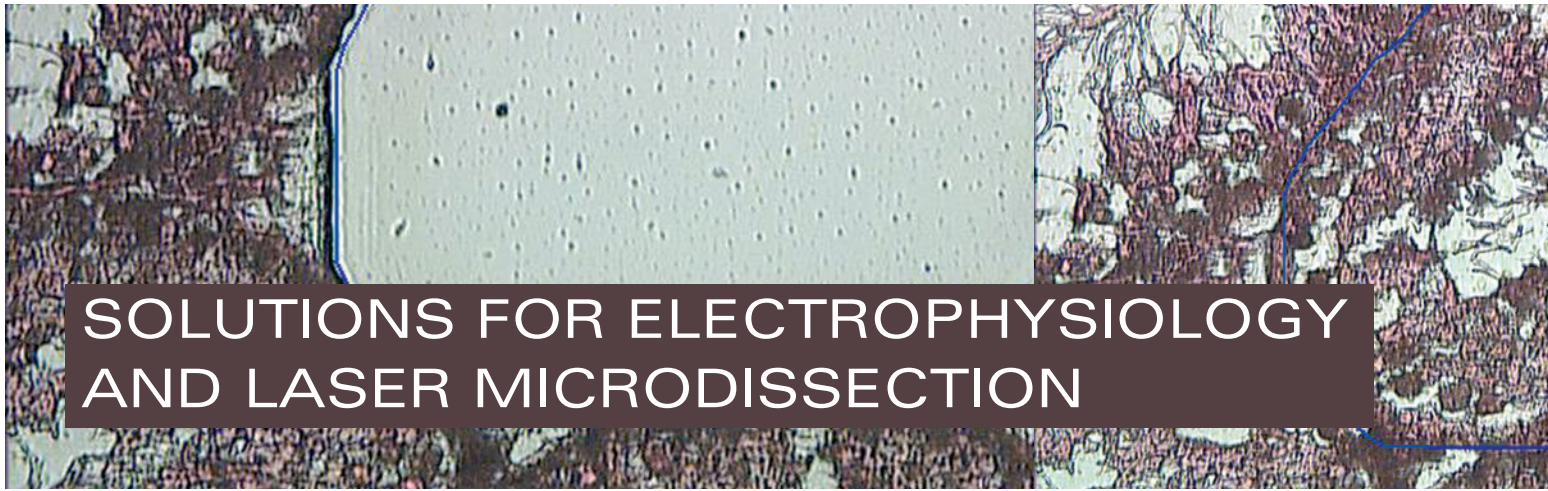

SOLUTIONS FOR ELECTROPHYSIOLOGY AND LASER MICRODISSECTION

The Leica DM6 stand is a platform for advanced microscopy techniques. The Leica DM6 FS is an outstanding tool to perform electrophysiological experiments, and the Laser Microdissection systems Leica LMD6 and LMD7 will help you to cut your samples with highest precision.

Laser Microdissection facilitates sample preparation for molecular biology analysis directly from the tissue section

- > UV laser beam movement via optics for fast, precise, and reliable laser cuts.
- > Specimen collection via gravity assures contact- and contamination-free sample collection.
- > Adjustable high-powered laser gives flexibility for a variety of specimens and applications.
- > Specially designed LMD objectives ensure the highest possible laser power.
- > Simple, time-saving, and workflow-based system functionality via easy-to-use software.

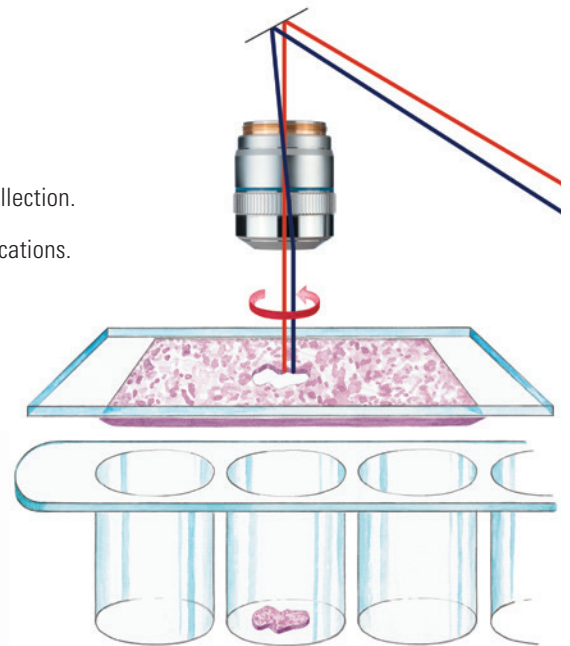



Fully automated fixed stage microscope for electrophysiological research and live-cell imaging

- > Tailored for electrophysiology – with special shielded cables and motors plus space for peripherals.
- > Combines DIC and epifluorescence with the recording or synchronization of electric signals
- > Eliminates all mechanical vibrations and electric interference for substantially improved stability of experiments.
- > More clearance around the specimens due to the HC FLUOTAR L 25x/0.95 W VISIR objective for near infrared DIC with the best possible access angle of 41° and largest free working distance of 2.5 mm.
- > Contact-free switchover and gentle submersion of the objectives into the aqueous nutrient medium with precise automatic refocusing due to the motorized two-position objective changer.
- > Ready for Optogenetics - in combination with adequate light sources and cameras.

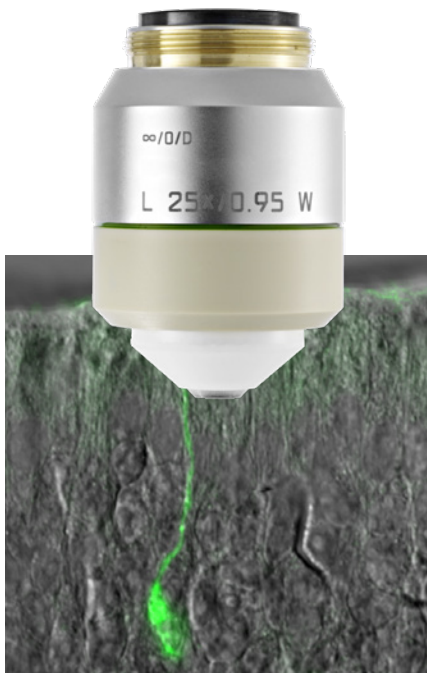

GFP-marked olfactory sensory neuron
Image courtesy of Dr. Daniela Flügge,
RWTH Aachen University, Germany



SPECIFICATIONS

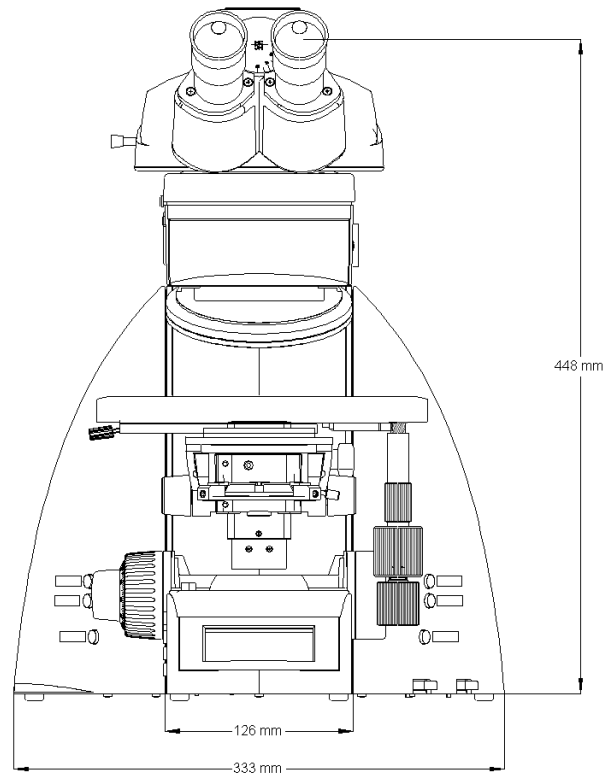
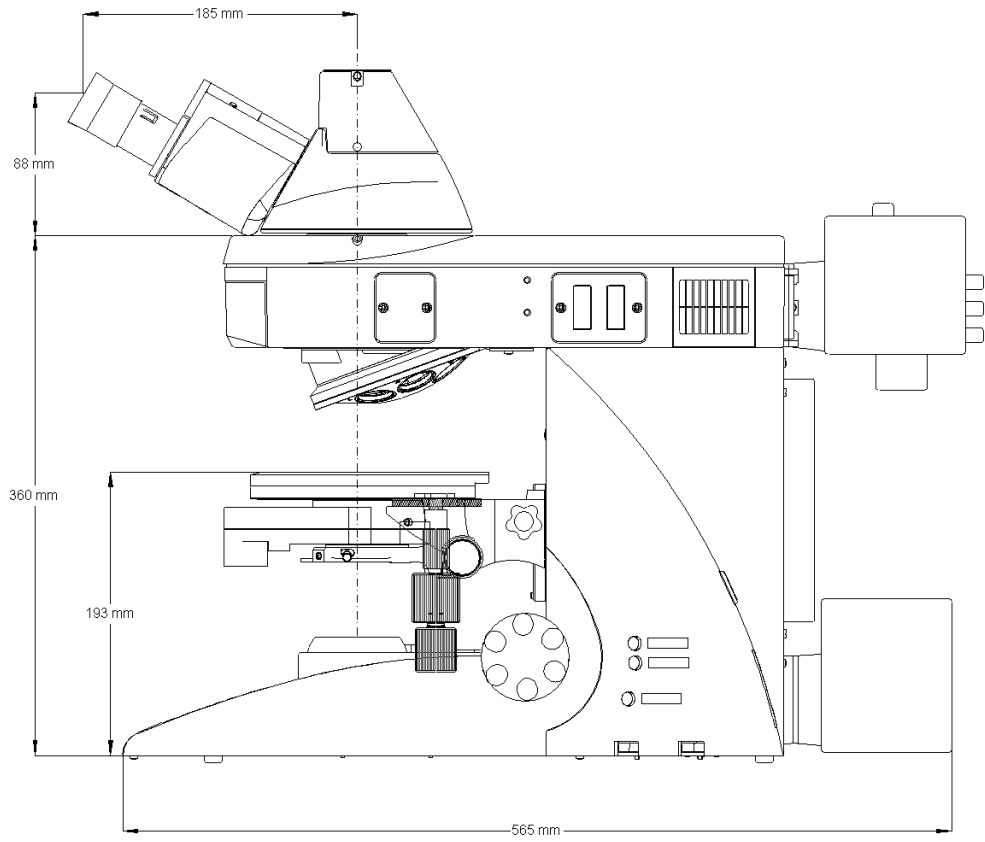

SYSTEM OVERVIEW		Leica DM4 B	Leica DM6 B	
Stand	Power supply	integrated within stand	within electronics box CTR6 LED	
	Display	information display	Leica SmartTouch with information and controls	
Operation	Interfaces	1 x USB 2.0, 1 x I ² C	2 x USB 2.0, 2 x I ² C	
	Focus	mechanical 2-ratio gearbox (coarse/fine)	motorized or mechanical 5 electronic ratios includes parfocal function switch between coarse and fine mode memory locations for two z-positions	
	Objective turret	absolute coded – 6x M25 thread – 7x M25 thread (optional)	motorized or absolute coded includes dry and immersion mode 7x M25 thread	
	Stage	mechanical ceramic-coated y-drive with belt removable stage drive with adjustable torque 110° swivel left-handed version optionally available	motorized (optional) with stepper motor switch between fast and precision mode includes memory location for up to 5 stage positions mechanical ceramic-coated y-drive with belt removable stage drive with adjustable torque 110° swivel left-handed version optionally available	
	Controls	6 programmable function buttons	6 programmable function buttons SmartMove controls for z (focus) movement and x,y (stage) movement 4 programmable function buttons Leica STP8000 controls for z (coarse and fine focus) and x,y (stage) movement 11 programmable function buttons touchpanel with information and control panels	
	LAS X Navigator	Yes	Yes	
Transmitted light axis	Illumination	LED	LED	
	Automation	Light manager: automatic Köhler light management sets the best values for aperture, field diaphragm, and light intensity Contrast manager: switch from one contrast method to another with one push of a button	Yes Yes	
	Contrast method	BF, PH, DF, POL DIC (semi-automated)	BF, PH, DF, POL DIC (fully automatic)	
	Motorized filter cube turret	5x	5x 8x	
Fluorescence axis	Illumination	Leica EL6000 Leica SFL100/4000, LED1, LED3 3rd Party	Leica EL6000 Leica SFL4000/7000, LED1, LED3 3rd Party	
	Automation	Fluorescence Intensity Manager (FIM): regulation of the excitation light to effectively protect the specimen from photo bleaching Contrast manager: switch from one contrast method to another with one push of a button Round and square illuminated field diaphragms for ocular and camera observation (motorized) Excitation Manager: balances fluorescence when viewing multiple probes simultaneously	Yes Yes Yes Optional	
	Internal Filter Wheel (IFW): fast switching between up to three wave lengths		Optional	
	Condensers	Automation	condenser head, motorized 7x condenser disk, motorized (optional) polarizer, motorized (optional)	condenser head, motorized 7x condenser disk, motorized (optional) polarizer, motorized (optional)

CONNECT
WITH US!

