

From Eye to Insight



# LEICA LMD6 LEICA LMD7

Laser Microdissection Systems

Dissection perfection

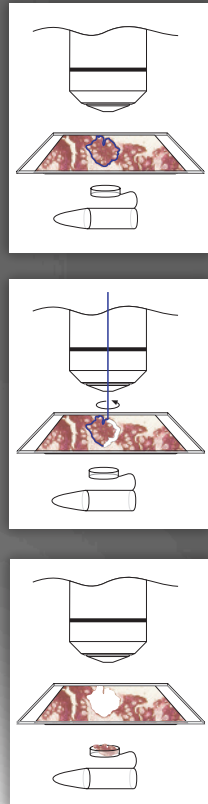

## LEICA LASER MICRODISSECTION SYSTEMS

Laser Microdissection (LMD) is a technology for precision sample preparation. In many areas of research it is a basic prerequisite for obtaining well-defined starting material for downstream experiments. Meaningful analyses in the fields of **genomics**, **transcriptomics**, **microarrays**, **next generation sequencing**, **biochips**, and **proteomics** are attained using this high-precision technology.

The Leica LMD systems perform sample preparation for molecular biology analysis directly from the tissue section using a UV laser.

The development of innovative new methods and new instruments has made laser microdissection popular in additional fields such as live cell research, climate research, and cover-slip engraving for electron microscopy.

Now, more than ever, researchers are using LMD to maximize their research impact.



## SUPERIOR SOLUTION

Leica Microsystems offers an extremely precise, highly selective laser microdissection method for a broad range of applications. Users of LMD use our superior systems for various applications:

- › Fast, precise isolation of ultra-pure cells and cell populations
- › High quality dissectates for genomics, transcriptomics, proteomics, metabolomics, and live cell applications
- › Convenient laser manipulation of live cells and other samples
- › Mark and track microscopic samples or sample holders

## METHOD OF CHOICE

The Leica LMD6 and 7 employ a very gentle, laser-based microscopic sample manipulation, dissection, and collection technique:

- › Patented laser beam movement via optics\*
- › Real-time live cutting directly on the sample with a Pen-screen
- › Patented specimen collection via gravity\*\*
- › Dedicated objectives for LMD
- › Adjustable laser settings
- › High-end, fully automated upright research microscope
- › Easy-to-use LMD Software

\* Patented EP 1276586, US 7035004, JP 3996773

\*\* Patented DE 10057292, EP 1207392, JP 3641454

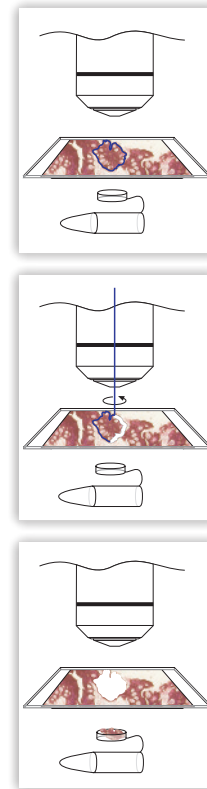

The Leica LMD process (from top to bottom):

**Step 1:** Define the region of interest

**Step 2:** Laser beam precisely steered by prisms along your definition

**Step 3:** Dissectate is collected by gravity



## DISSECTION PERFECTION

Observe and obtain ultrapure and homogenous samples from heterogeneous starting material – contact- and contamination-free simply by gravity. The Leica LMD6/7 systems make this possible: they combine a fully automated upright high-end research microscope and a UV laser.

### TWO SYSTEMS, TWO DIFFERENT LASERS

Leica offers two freely configurable laser microdissection systems: the Leica LMD6 (Fig. left) and the Leica LMD7 (Fig. right). Both systems are based on a high-end upright research microscope (Leica DM6 B). In addition to the advanced functions of this fully automated research microscope, Leica LMD systems enable you to isolate and manipulate microscopic samples in a contact- and contamination-free manner. The difference between the two systems is the laser power and flexibility. The laser settings of both systems can be adjusted to perfectly match the needs for your application.

- › The LMD6 is ideal for standard laser microdissection applications, e.g. reliable single cell or tumor isolation from soft tissue sections.
- › The LMD7 has a high power laser with additional options to adjust the laser pulse frequency and laser head current for dissection of hard tissues like bone, teeth, wood or plant tissue as well as chromosomes.

LASER COMPARISON

	LMD6	LMD7
Wavelength	355 nm	349 nm
Pulse frequency	80 Hz	10–5.000 Hz
Pulse length	< 4 ns	< 4 ns
Max. pulse energy	70 µJ	120 µJ



## ADVANTAGES OF LASER MICRODISSECTION

### Leica Laser Microdissection –

simple, intuitive, gentle, and smart sample isolation, collection, and manipulation.

#### › Laser beam movement via optics\*:

- Fast, precise, and reliable laser cuts
- Real-time cutting while sample remains fixed
- Convenient documentation by time lapse movies

#### › Specimen collection via gravity:

- Simple, gentle, contact- and contamination-free
- Allows standard consumables for collection
- No limitation of size or shape of dissectate
- Pool unlimited amounts of dissectates

#### › Adjustable high-powered laser:

- Flexible for a variety of specimens and applications
- Full control of laser power, laser aperture, laser speed, laser frequency (Leica LMD7), and laser focus

#### › Fully integrated fluorescence:

- Specially designed fluorescence filter cubes
- Live cutting within brightfield and fluorescence

#### › Upright microscope:

- All benefits of a fully automated high-end research microscope
- Safer and smart dissectate collection by gravity without any additional force
- LED illumination

#### › Specially designed LMD objectives:

- Ensure the highest possible laser power
- Range of dedicated LMD objectives: 5x, 6.3x, 10x, 20x, 40x, 63x and 150x
- 1.25x for fast slide overviews
- Objectives for additional applications (other than LMD applications, e.g. 100x oil for FISH)

#### › Easy-to-use software:

- Simple, time-saving, and workflow-based system functionality
- Additional modules for automated pattern recognition (ADM) and automated image capture and documentation (LIF database)

#### › Leica camera range:

- Choose a camera specific to your application
- Attach up to two cameras (e.g. one for fluorescence, one for brightfield)



\* Patented EP 1276586, US 7035004, JP 3996773

\*\* Patented DE 10018255, JP 4236844



## CONSUMABLES

Leica Microsystems offers application specific consumables for laser microdissection with different types of membranes on metal frames, glass slides, and ibidi® and Petri dishes in different sizes. Whether you need slides that have no autofluorescence, use DIC contrast to view the specimen, or need a suitable surface for growing cell cultures – Leica Microsystems has the perfect solution for your application.

### FOR DISSECTION WE RECOMMEND

- › Leica MembraneSlides: glass slides with PEN or PPS membrane
- › Leica FrameSlides: steel frames with PEN, PPS, PET, POL or FLUO membrane
- › Leica CoverslipSlides: coverslips with PEN membrane
- › All membranes are highly UV-absorbent
- › DIRECTOR™ slides
- › Petri dishes with PEN membrane
- › ibidi® slides (e.g. 18-well) with PEN membrane\*
- › Membrane rings with PEN membrane\*
- › In addition, Leica LMD Systems support collection from plain glass slides (Draw+Scan ablation)

\* suitable for stack dissection and collection

### RANGE OF COLLECTION DEVICES

For motorized, scanning and LMT350 stages:

- › Standard PCR tube caps 0.2 ml/0.5 ml
- › 8-strip wells
- › Petri dishes with or without PEN membrane

For scanning stage only:

- › 8-strip caps (suitable for 8-strip wells and 96-well plates)
- › ibidi® slides
- › Multi-well slides (dimensions max. 76 x 26 mm)

For LMT350 stage only:

- 12-strip caps
- 1.5 ml tube
- 96-PCR-well plate / 96-LCC-well plate

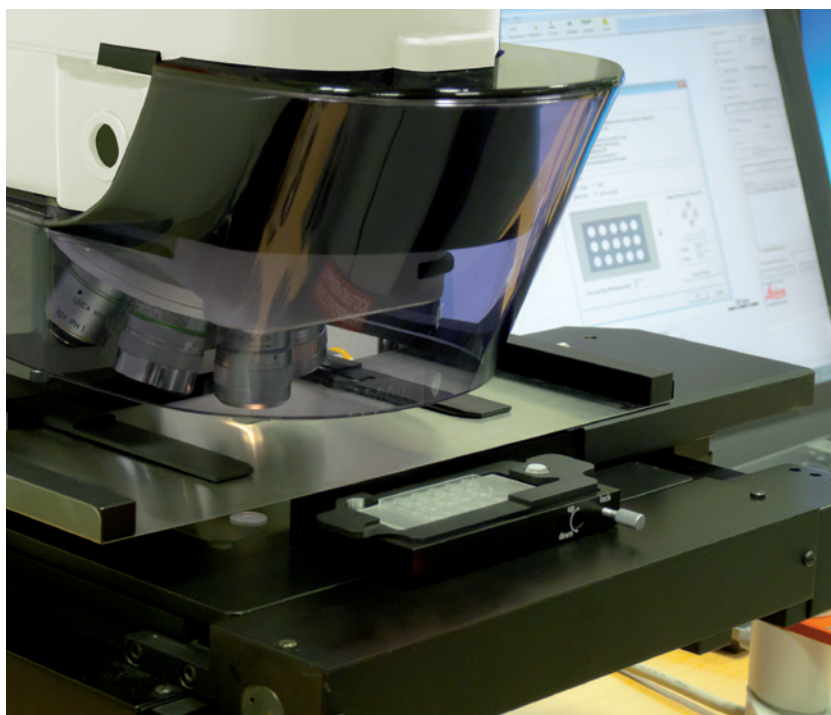
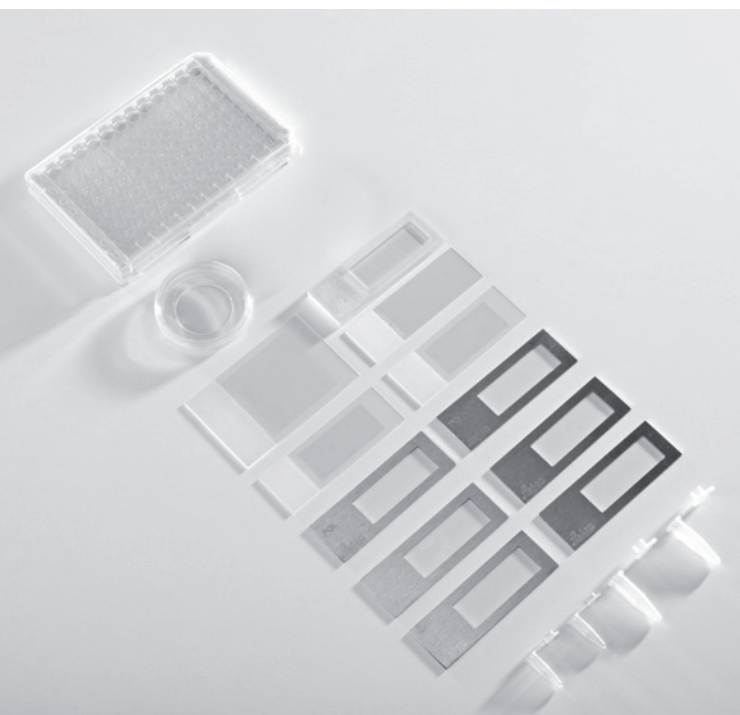

## STAGES\* AND HOLDING DEVICES FOR LMD SYSTEMS

### The motorized stage

#### HOLDERS



Holder for 1 slide  
(25 x 76 mm)  
11532732



Holder for big slide  
(50 x 76 mm)  
11505214



Holder for Petri dish  
with PEN membrane bottom  
11505257

#### COLLECTORS

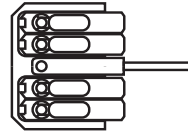

Collector with lever  
for tube caps\*\*  
(4 x 0.2 ml PCR tubes)  
11505131

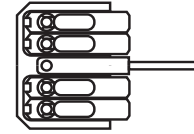

Collector with lever  
for tube caps\*\*  
(4 x 0.5 ml PCR tubes)  
11505130

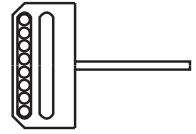

Collector for 8-well  
strip tubes  
(high volume)  
11505258

\*\* Patented DE 10057292, EP 1207392, JP 3641454

### The scanning stage

#### HOLDERS



Holder for 3 slides  
(25 x 76 mm)  
11505226



Holder for big slide  
(50 x 76 mm)  
and Petri dish  
with PEN membrane bottom  
11505227



Holder for 18-well ibidi®  
slides and slide stacks  
11505255

#### COLLECTORS



Collector for  
tube caps  
(4 x 0.2 ml PCR tubes)  
11505229

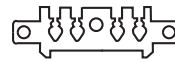

Collector for  
tube caps  
(4 x 0.5 ml PCR tubes)  
11505228



Universal collector  
for 8-strip tubes,  
8-strip caps, slides  
(Multi-well slides, ibidi®,  
etc.) and chamber slides  
11505276

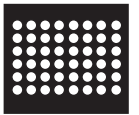

Universal collector  
for 6x8-strip caps  
included in  
11888852

### The LMT350

#### HOLDERS AND ADAPTER



Holder for 4 slides  
(25 x 76 mm)  
11505304



Adapter for  
large slides  
11505311



Adapter for  
petri dishes  
11505312



Adapter for  
18-well ibidi®  
slides  
11505313

#### COLLECTORS



Multicollector  
11505305



Collector for tube caps  
(4 x 0.5 ml PCR tubes)  
11505306



Collector for tube caps  
(4 x 0.2 ml PCR tubes)  
11505307

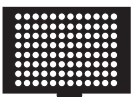

Inlay  
96-PCR 11505308  
96-LCC 11505310  
96-Fully Skirt 11533579  
14x24 mm tubes  
11533577

## UNIQUE LASING WITHIN FLUORESCENCE

The ability to perform fluorescence imaging and laser microdissection simultaneously is becoming more important. Lasing within fluorescence using the unique patented axis-and filter-system\* is one of the strengths of the Leica LMD systems. Whether you are inspecting and dissecting immunolabeled tissue sections or live cells expressing a fluorescent protein – the laser microdissection systems Leica LMD6 and Leica LMD7 make this a standard procedure. In addition, the fully automated fluorescence axis minimizes bleaching effects, accelerates your processes, and offers the exactly reproducible experiment conditions if required.

### EXAMPLE

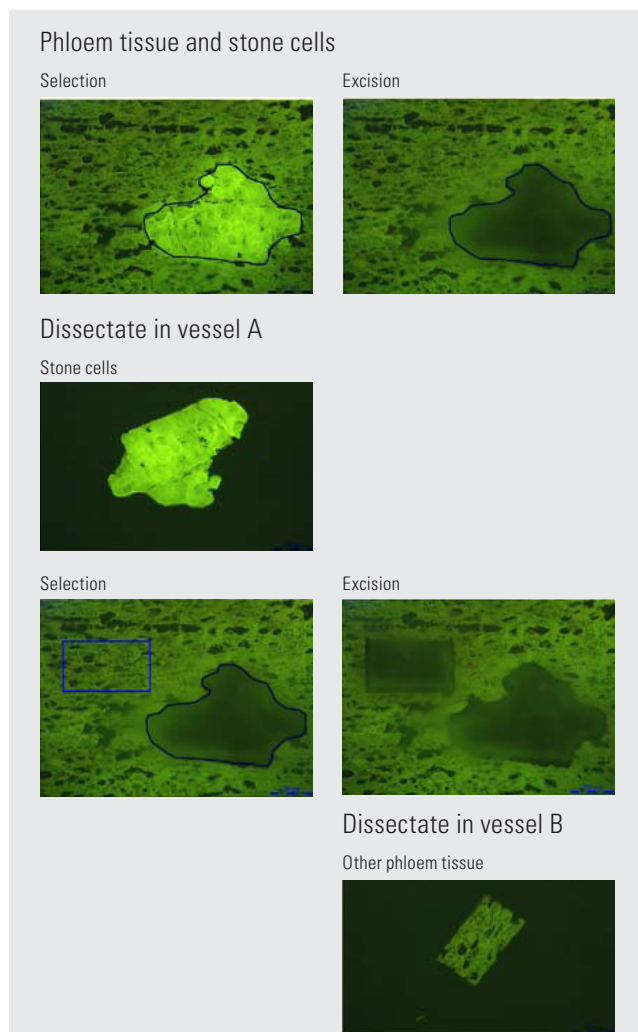

### LMD FLUORESCENT FILTER SYSTEMS

The Leica's range of specialized LMD fluorescence filter systems is continuously growing. These LMD filter systems are from the ET series, are sputtered, and feature impressively steep edges of the excitation and emission spectrum.

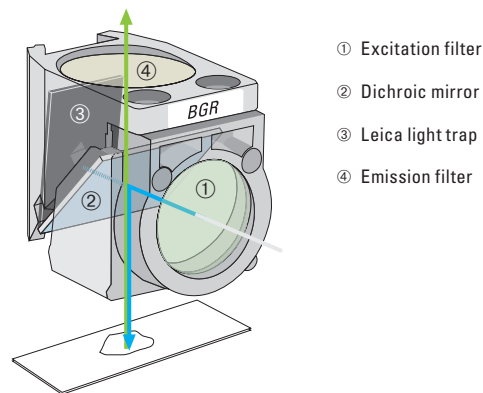

Several newly developed fluorescence filter systems for LMD allow the unique simultaneous cutting under fluorescence:

- › Leica LMD-BGR
- › Leica LMD-Alexa594
- › Leica LMD-GFP band pass
- › Leica LMD-CFP
- › Leica LMD-GFP long pass
- › Leica LMD-GFP/Cy3
- › Leica LMD-Cy3
- › Leica LMD-YFP
- › Leica LMD-DAPI
- › Leica LMD-Cy5

\* Patented EP 1719998, US 7485878



## DEDICATED LASER MICRODISSECTION OBJECTIVES

Leica Microsystems offers a portfolio of dry objectives dedicated for Leica LMD systems. These special LMD objectives feature the highest possible UV-transmission and outstanding imaging performance – the Leica SmartCut series (5x–150x).

Objective	Mag.	NA	WD (mm)	BF, POL	FL	DIC, PH	LMD	CI	SOV
HCX PL FLUOTAR**	1.25x	0.04	3.7	+	+	–	–	–	+++
PLAN UVI	2.5X	0.07	11.7	+	+	–	+++	++	+++
PLAN**	4x	0.1	26.2	+	+	–	+	++	++
UVI	5x	0.12	11.7	+	+	–	+++	++	++
HI PLAN	6.3x	0.13	12.8	+	+	–	+++	++	++
HCX PL FLUOTAR	10x	0.3	11.0	+	+	+	+++	+	+
UVI	10x	0.25	2.9	+	+	+	+++	–	+
HCX PL FLUOTAR	20x	0.4	6.9	+	+	+	+++	+	+
HCX PL FLUOTAR	40x	0.6	3.3–1.9	+	+	+	+++	–	–
HCX PL FLUOTAR	63x	0.7	2.6–1.8	+	+	+	+++	–	–
HCX PL FLUOTAR	150x	0.9	0.25	+	+	+	+++	–	–

Mag. – magnification; NA – numerical aperture; WD – working distance; BF – brightfield; POL – polarized light; FL – fluorescence; DIC – differential interference contrast; PH – phase contrast; LMD – laser microdissection; CI – cap inspection; SOV – specimen overview; + = suitable; – = not suitable; +++ = dedicated for; +++ = most suitable

\*\* Additionally recommended objectives

## OTHER OBJECTIVES

In addition to the LMD objectives, any other Leica objectives can be used with the Leica DM6 B upright microscope for specific applications (e.g. for FISH). In the table above, the 1.25x objective is used for fast specimen overviews and the 4x objective is dedicated for cap inspection.



## CAMERA PORTFOLIO

Transmitted light, fluorescence or both: Leica LMD systems and software support a range of digital cameras for different requirements.

Choose the new Leica LMD CC7000 digital color camera dedicated for LMD applications. The highly compact LMD color camera Leica LMD CC7000 (# 11501478) is a GigE camera with 1/3" interline progressive scan CCD sensor and 1.2 Megapixel resolution. Experience the speed of the new Leica LMD CC7000, unique for Leica LMD systems.

Leica LMD CC7000 digital color camera

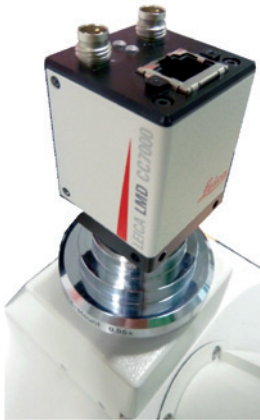

Choose from the portfolio of Leica microscope cameras



**Left: Leica LMD6 with one camera:**  
The Leica LMD CC7000 for ultra fast digital live images

**Right: Leica LMD7 with two cameras:**  
The Leica DFC7000 T for ultra fast digital live images and the Leica DFC365 FX for demanding fluorescence.

Dual camera support allows you to combine any two cameras, thus making your system a multifunctional tool for any kind of application!

For Leica LMD6 the set-up with 2 cameras is different.



## LIVE CELL CUTTING ACCESSORIES

The Leica LMD systems are ideal for any kind of live cell application. With our “sandwich-technology” using membrane rings or our ibidi® slides’ sterile microchambers\*, live cells are easily dissected in a sterile environment. The LMD system can also be equipped with a climate chamber and full climate control. The time lapse movie function in combination with the laser beam movement by prisms makes it the perfect tool for your laser manipulation experiments. Collect cells or cell clusters via gravity, without any additional force or handling steps, directly into culture media for immediate recultivation, or, alternatively, into collectors for downstream analysis.

### APPLICATION EXAMPLE: TRANSGENIC FLUORESCENT CELLS

Human forensic fibroblasts infected with human cytomegalo virus, HCMV-GFP fusion protein (Courtesy of Margarete Digel and Dr. Christian Sinzger, Institute of Medical Virology, UKT University of Tübingen, Germany)

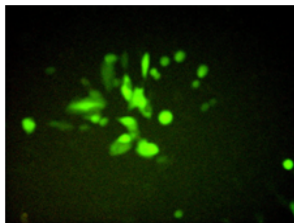

Before microdissection

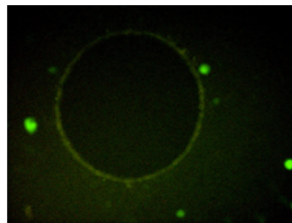

After microdissection

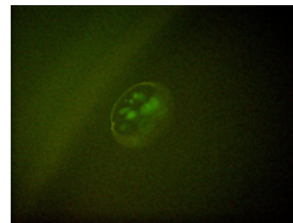

Infection of microdissected fibroblasts

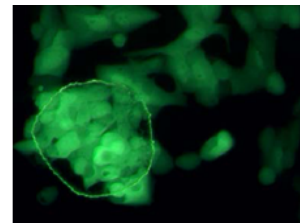

4 days after recultivation

Classical selection of infected cells followed by dilution series takes 2 months.

Leica LMD climate chamber with environmental control

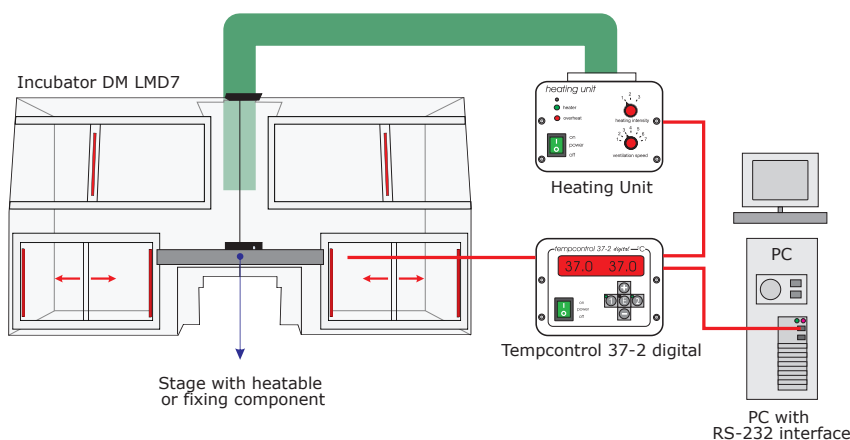

Patented\*\* universal holder with different slides suitable for live cell applications

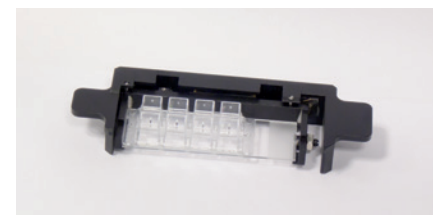
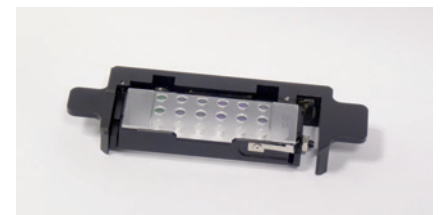

\* Patented US 7807108

\*\* Patented DE 102009029078

## EASY-TO-USE SOFTWARE

Leica LMD Software offers the functions necessary for perfect Laser Microdissection or Laser Manipulation. With full control of all laser settings you can adjust the laser to your specimen, independent of shape or size.

Improve your experiments with the different drawing tools and cutting modes.

Enjoy the intuitive user interface and the speed of the system and fully automated fluorescence, DIC, PH and POL.

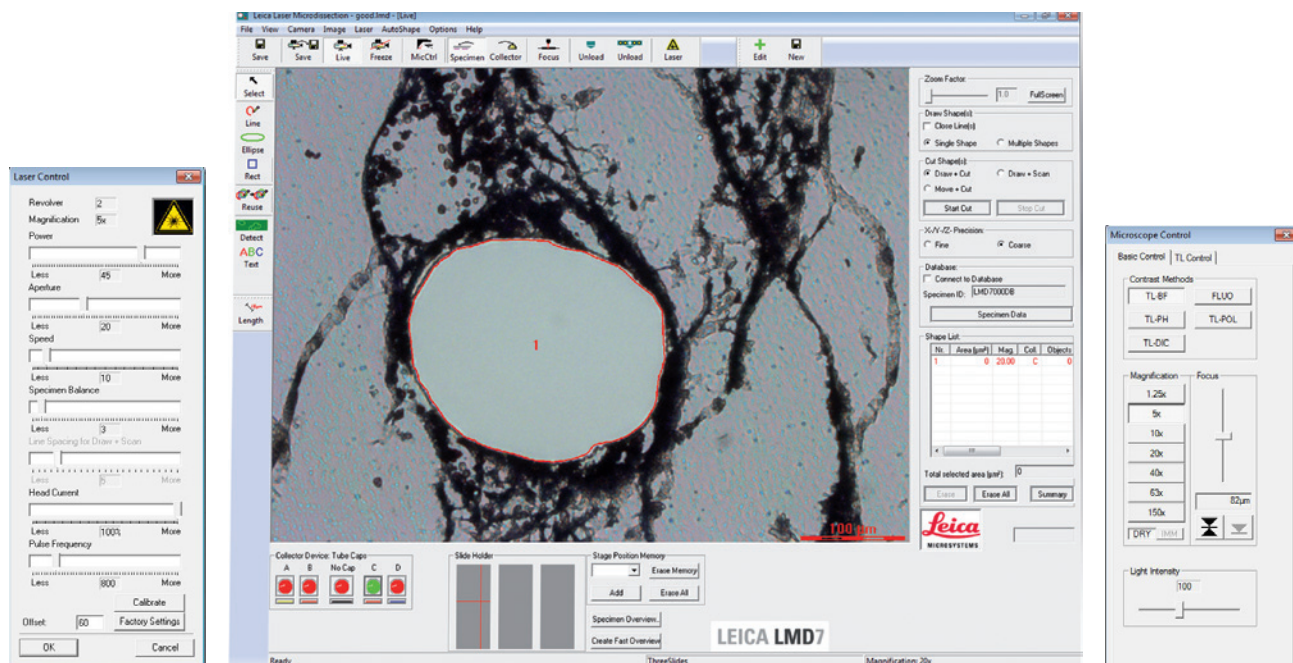

### FEATURES ARE ALREADY INCLUDED IN THE LMD CORE SOFTWARE, FOR EXAMPLE:

- › Full microscope control including illumination method, camera control, specimen and collector holders
- › Full control of all laser settings for adjustment to any type of sample
- › Specimen overview images for optimal orientation and navigation
- › Time lapse movie function for application recordings, the sample stays fixed even during laser applications
- › Different cutting modes and drawing tools to either dissect and pool or separate specimens of different sizes and shapes
- › Annotation and length measure tool for documentation
- › Image capture function for documentation
- › Save and restore application settings to ensure quick and easy experiment starts



# SOFTWARE MODULES

## RETAIN ALL INFORMATION: LEICA LMD DATABASE

- › Automated storage of images prior to cut, after cut, and after cap inspection
- › Full access to all experiment parameters
- › Shared database LIF-file format for image access and processing with Leica LAS AF (Leica Application Suite, Advanced Fluorescence)
- › Image export to current image file formats (JPG, TIF, ...)

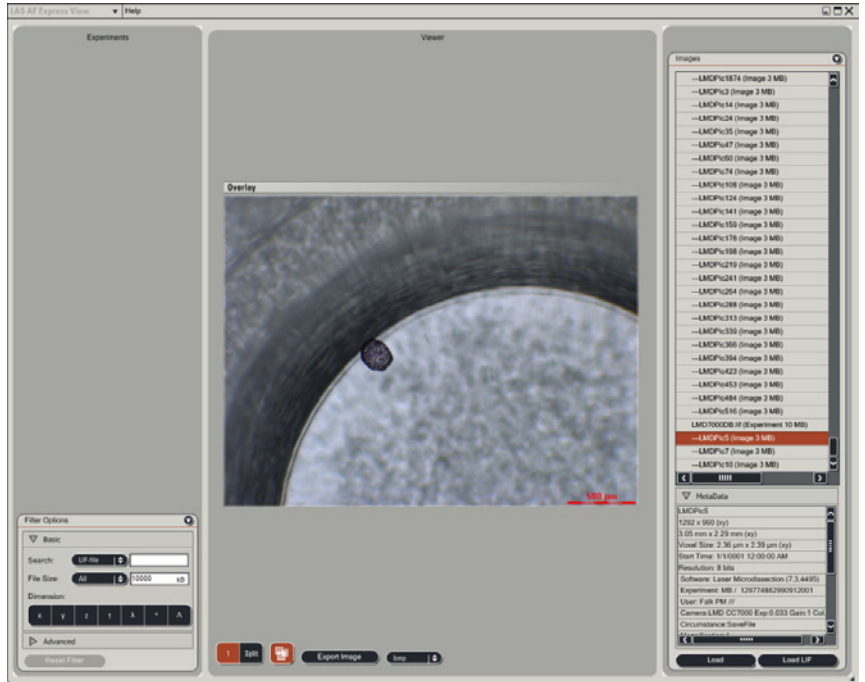

## SPEED UP YOUR LMD APPLICATION: ADM (AUTO DETECTION MODE\*) FOR PATTERN RECOGNITION

- › Automated marking of cutting lines to avoid time-consuming manual selection
- › Fully integrated solution for automated pattern recognition
- › Easy-to-use interface
- › Works well with any kind of specimen (transmitted light and fluorescence)
- › Option to save and restore different settings
- › Smart autofocus for best performance in different field of views

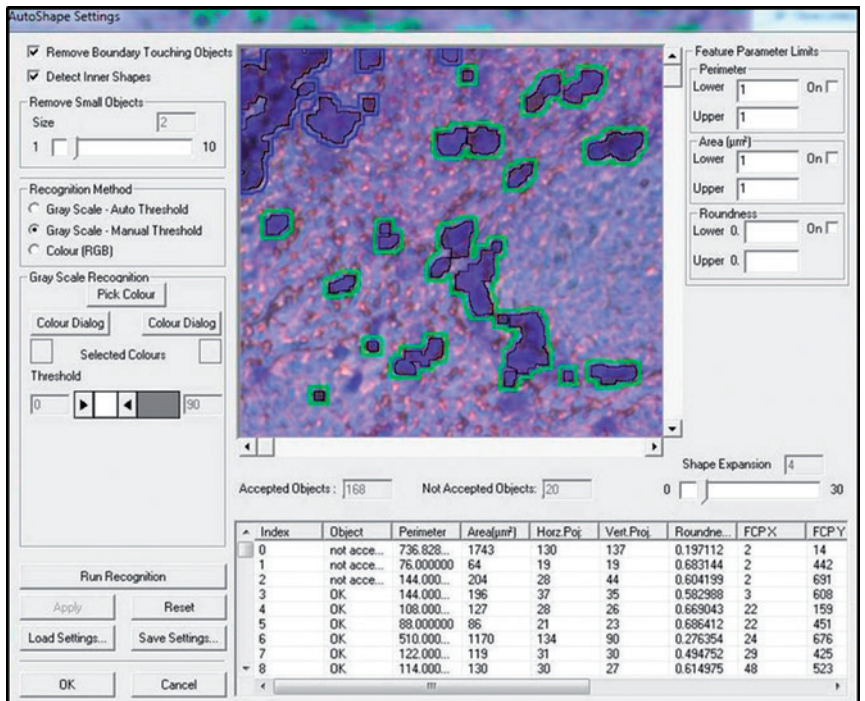

\* Patented EP 1676116



## SUMMARY

Maximize your impact  
with a Leica LMD system

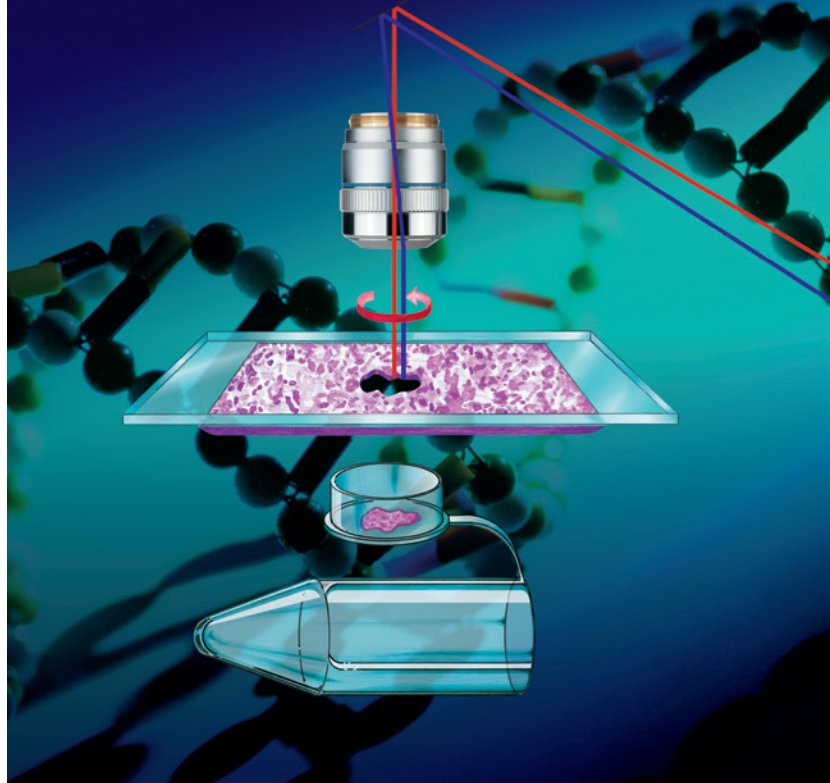

### MAIN APPLICATION FIELDS FOR LEICA LASER MICRODISSECTION SYSTEMS

- › Cancer research
- › Pathology
- › Molecular biology research
- › Neuroscience research
- › Developmental research
- › Plant research
- › Forensic research
- › Physiology research
- › Clinical research
- › Pharmaceutical research
- › ... almost anywhere

### MAIN APPLICATIONS FOR LEICA LASER MICRODISSECTION SYSTEMS

- › Extraction of homogeneous samples from heterogeneous starting material for genomic, transcriptomic, proteomic, and metabolite analysis
- › Live cell cloning, manipulation, and re-culturing
- › Ablation and damage of live cells, tissues, and embryos monitored by time-lapse movies
- › Thrombosis inducement
- › TEM sample selection before resin embedding
- › Engraving coverslips for CLEM application
- › NanoSIMS support
- › ... your own unique application

### BENEFIT FROM MORE THAN 10 YEARS OF EXPERIENCE

- › Third generation of proven Leica LMD systems
- › Workflow-based, easy-to-use, powerful software
- › Large, fast growing library of scientific publications
- › Knowledgeable, experienced Leica support personnel

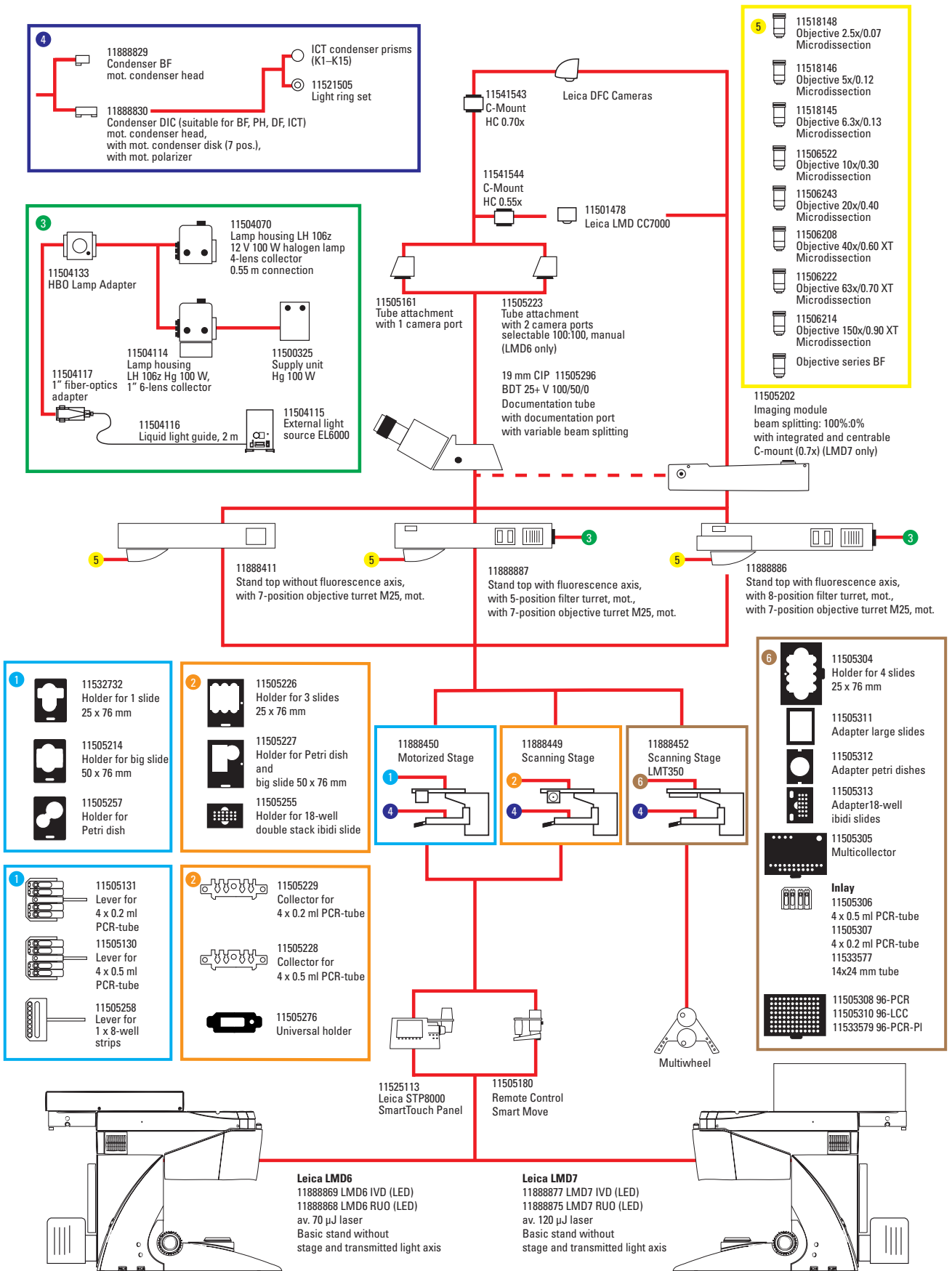

The Leica LMD6/7 microscopes comply with the Council Directive 98/79/EEC concerning *in vitro* diagnostics.

They also conform to the Council Directives 2006/95/EG concerning electrical apparatus and 2004/108/EG concerning electro-magnetic compatibility for use in an industrial environment.

Leica Microsystems CMS GmbH | Ernst-Leitz-Strasse 17–37 | D-35578 Wetzlar (Germany)

Tel. +49 (0) 6441 29-0 | F +49 (0) 6441 29-2599

[www.leica-microsystems.com](http://www.leica-microsystems.com)

CONNECT  
WITH US!

