

From Eye to Insight



Perfect for Geology, Education, and Material Inspection

SHINE A NEW LIGHT ON YOUR SAMPLES

The DM750 P





SCIENCE TEACHING REVITALIZED

The more time an instructor has to teach, the more students can learn. The Leica DM750 P polarizing microscope was specifically developed to revitalize earth science teaching and to achieve the goal of more hands-on time for Earth and Materials Science courses. With many student-friendly features and high-quality construction, the Leica DM750 P is the right tool to invigorate Petrography, Crystallography, and Materials Science learning and teach the next generation of scientists effectively and efficiently.

SUPERB OPTICS

- › Based on the same optical platform as Leica Microsystems' research microscope line users enjoy outstanding optical performance and full access to virtually all accessories from the Leica Microsystems microscope product line.
- › Strain-free objectives and condensers make the sample the only part effecting the polarized light.

USB POWER CONNECTOR

- › Providing power to the Leica USB cameras and reflected light Illuminator is extremely easy. Simply connect the camera via the provided USB cable to the 5 V/1.5 A USB power connector on the rear of the Leica DM750 P stand. This saves the cost of an external power supply for the camera plus reduces the complexity at the workstation.

EZSTORE™

- › Integrated vertical handle provides easy carrying and lifting when storing on high shelves; undercut on front of stand works in combination with the handle for safer, two-handed carrying.
- › Integrated cord wrap eliminates damage to microscope components from improper cord wrapping; vertical cord insertion prevents the cord from pulling partially out of the stand while in storage or in use.
- › Onboard storage of accessories to prevent loss.
- › The unique shape of the microscope stand protects controls from damage when microscopes are stored side-by-side.

AGTREAT™

- › The possible contamination with germs from surfaces is of great concern, especially in educational environments. Leica Microsystems has integrated an additive to the material of all microscope touchpoints to inhibit the growth of bacteria. This helps prevent the spread of disease via the microscope surfaces and leads to a healthier laboratory environment.



THE FUTURE IS NOW

The Leica DM750 P is designed specifically for the versatile needs of Earth and Material Science Courses.



SIMPLICITY

- › Analyzer module to accommodate analyzer sliders for basic polarisation microscopy
- › Conoscopy analyzer/Bertrand lens module with upfront clearly labeled flip in/flip out controls to prevent dust damage and confusion of operation. Bertrand lens is easily centerable with the provided tool (stored in module)
- › Conoscopy advanced analyzer/Bertrand lens module also provides a focusable Bertrand lens to fine tune the focus of the Conoscopic Image for different magnifications
- › Onboard storage locations for two nose-piece compensators and the objective centering tools to prevent loss



READY TO WORK

- › Large 177 mm diameter stage for easy specimen placement and viewing of calibrations
- › Brake for locking the stage in position
- › Object guide for precise X/Y positioning of the specimen
- › Laser engraved stage eliminates the chance for the stage calibrations to rub off over time





OPTIONAL LED REFLECTED LIGHT

- › Reflected light illuminator with capability for brightfield, oblique and polarized light

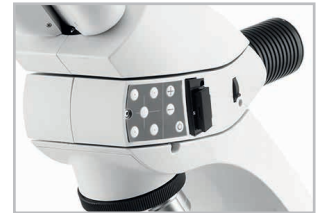

OPTIMIZED ILLUMINATION

- › LED illumination provides cool, white light with a life-time of over 20 years average use. No longer need to change lamps during lab time and save the expense of replacement lamps
- › Koehler field diaphragm for optimum illumination and contrast
- › Time delay shutoff saves energy by automatically turning off the illumination after 2 hours of no use

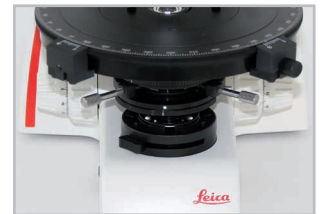

VERSATILITY

- › Strain free standard condenser for magnifications 4x – 100x with slot for ¼ wave compensator for circular polarization technique
- › Optional Flip Top condenser for low magnifications
- › Aperture diaphragm with marks for the correct position of typical objective magnifications for intuitive learning and operation



ALIGNED VIEWING

- › 4 Position individually centerable nose-piece for exact durable centration of each objective to the stage rotation axis
- › 30° angle for comfortable viewing
- › Integrated mechanism to maintain eye-piece crosshair orientation during IPD adjustment



BRILLIANT VIEWS WITH HD IMAGING

The ability to share, capture, and archive images is becoming an important part of the microscopy laboratory. Now you can share your images with the new microscopy cameras from Leica Microsystems for advanced imaging solutions.

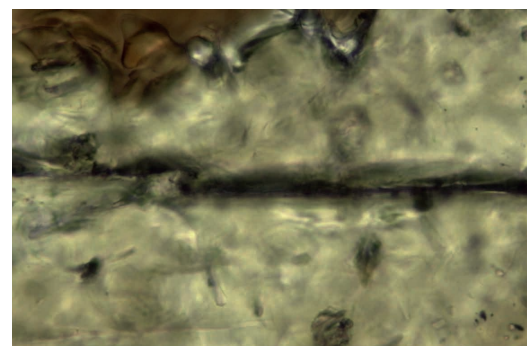
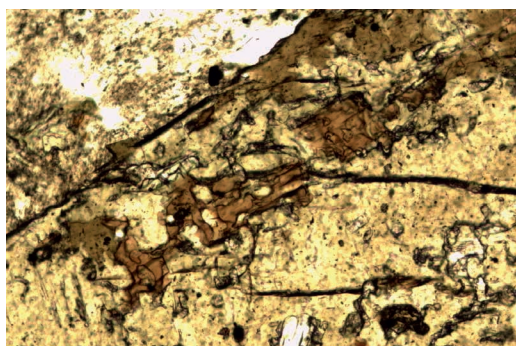
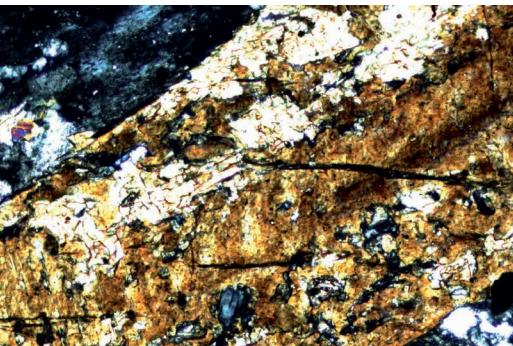
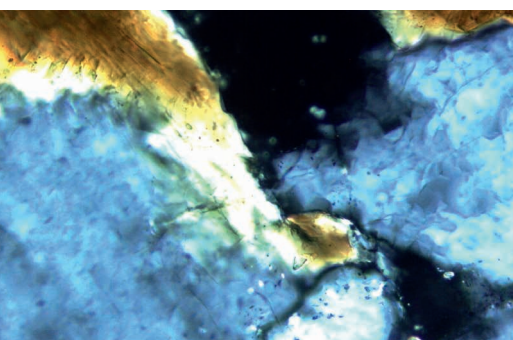
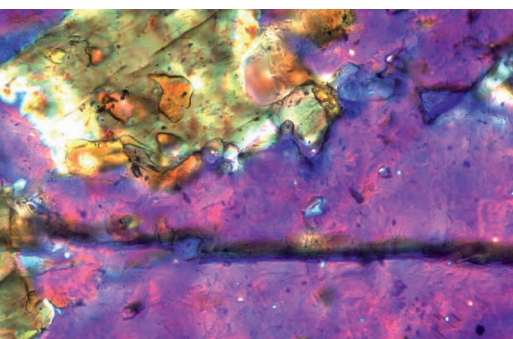
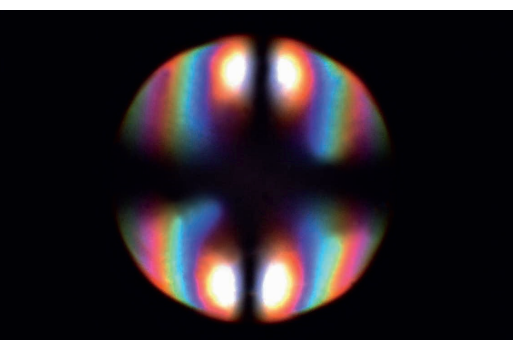

LEICA IMAGING

- › A variety of Leica microscopy cameras including Full HD viewing. Different cameras provide high resolution pictures and fast live images.
- › The Leica ICC50 W wireless HD camera provides a WiFi mode to wirelessly broadcast an HD image directly to your mobile device for independent annotation and image capture by several students.
- › When using the Leica ICC50 W, download the Leica AirLab app for camera setup, annotations, measuring, image capture, and sharing to email, photo folders, or other social media connections.
- › The Leica ICC50 W can be powered directly from the Leica DM750 P stand eliminating the need for a separate power supply.
- › Customize your own Imaging Solution using a wide selection of optional Leica Microsystems software modules.
- › The modular design of the system allows easy upgrades and service.
- › Trinocular viewing tubes and C-mount adapters provide the versatility to use stand-alone cameras which opens the door to unlimited imaging possibilities.



Full HD
1080



SYSTEM DIAGRAM DM750 P

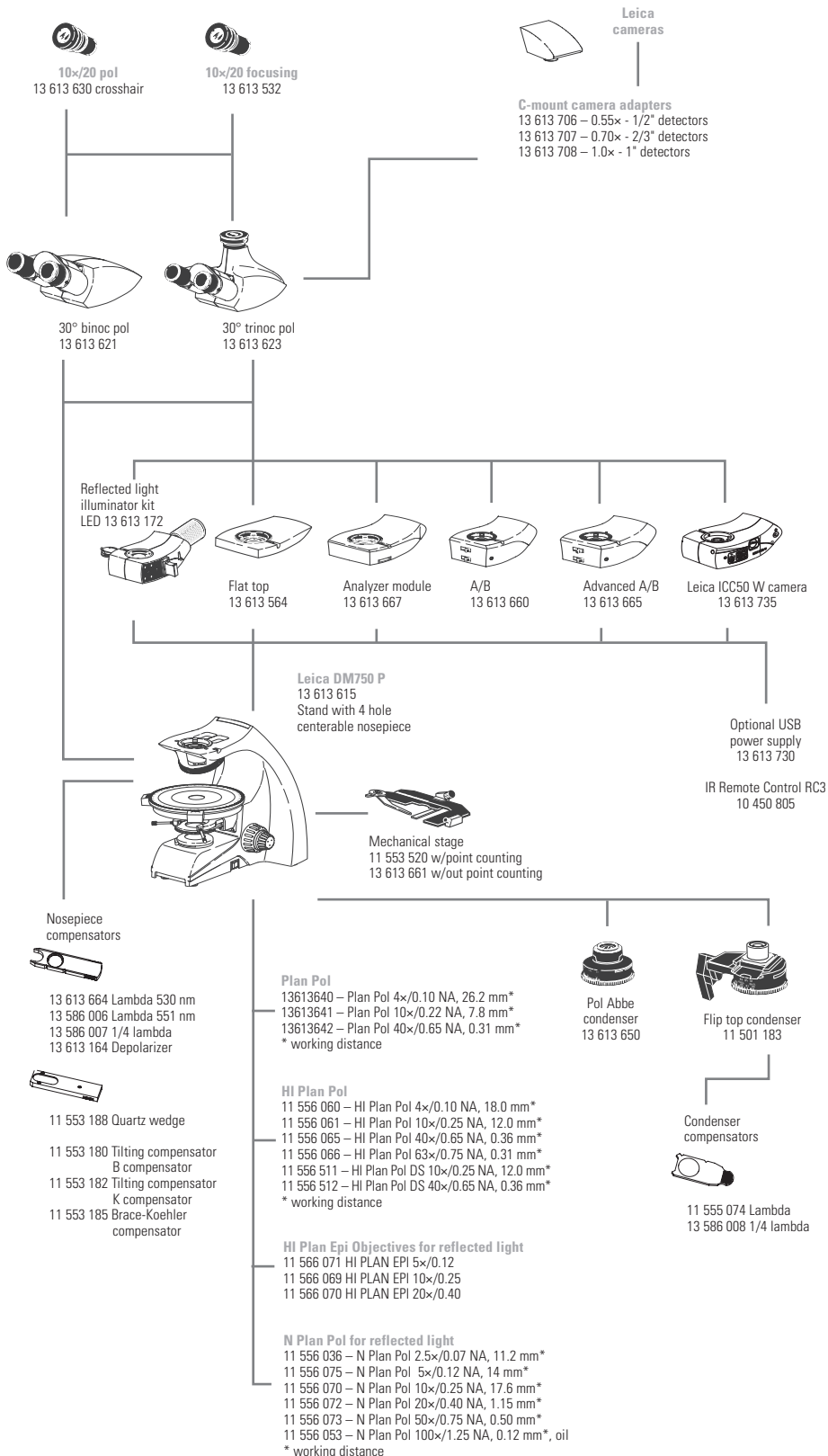

- Reflected light**
13 613 172 Pol reflected light illuminator kit – LED consists of:
13 613 171 – Illuminator
11 555 005 – Polarizer R/P with 0°, 45°, and 90° click stops
11 555 079 – 180° rotatable analyzer slider
- Additional polarizer sliders for reflected light**
11 565 001 Polarizer with lambda plate
11 555 084 Polarizer 360° rotatable
- Analyzer sliders**
11 555 045 Fixed analyzer slider
11 555 079 180° rotatable analyzer slider
11 555 080 360° rotatable analyzer slider
- Replacements**
13 613 563 Eyeguard pair
13302138946910 Fuse
13 613 662 Objective centering tools
13 613 671 Thumbscrew pair Leica DM750 P condenser mount
13 583 041 Object clamps for Leica DM750 P
13 613 611-100 Leica DM750 P user Documents
13 586 062 Add-on lens for condensers (included with stand)
13 613 669 Dust cover
- Others**
11 513 106 Stage micrometer
11 505 091 Diffuser slider for using 2.5x objective with Abbe condensers
11 505 507 Auxilliary lens for using 2.5x objective with 11 501 183 flip top condenser
13 613 164 Depolarizer – fits into compensator slot
- International power cords**
13 613 900 U.S.
13 613 901 Europe Continental
13 613 902 U.K.
13 613 903 Switzerland
13 613 904 Denmark
13 613 905 Italy
13 613 906 Australia
13 613 907 China
13 613 908 Japan
13 613 909 Israel
13 613 910 South Africa
13 613 911 India
13 613 912 Argentina

PRECONFIGURED OUTFITS DM750 P

OUTFIT ORDERING NUMBER		13 613 617	13 613 618
		DM750 P	DM750 P
STAND			
13 613 615	DM750 P Stand Koehler, 4 position centreable nosepiece	X	X
TUBES			
13 613 621	30° Binocular Pol Tube	X	X
EYEPIECES			
13 613 532	10×/20 Focusing eyepiece w/eyeguard	X	X
13 613 630	10×/20 focusing eyepiece with eyeguard, crosshair reticule, and key for orientation	X	X
POL MODULES			
13 613 660	Analyzer/Bertrand Lens Module	X	X
COMPENSATORS			
13 613 664	Lambda Compensator 530 nm	X	X
CONDENSERS			
13 613 650	Pol Abbe Condenser 0.85	X	X
POL OBJECTIVES			
13 613 640	Plan Pol 4×/0.10 NA, 26.2 mm W.D.	X	X
13 613 641	Plan Pol 10×/0.22 NA, 7.8 mm W.D.	X	X
13 613 642	Plan Pol 40×/0.65 NA, 0.31 mm W.D.	X	
11 556 066	HI Plan Pol 63×/0.75 NA, 0.31 mm W.D.		X
POWER CORD NOT INCLUDED: Must be ordered separately.			

DIMENSIONS DM750 P

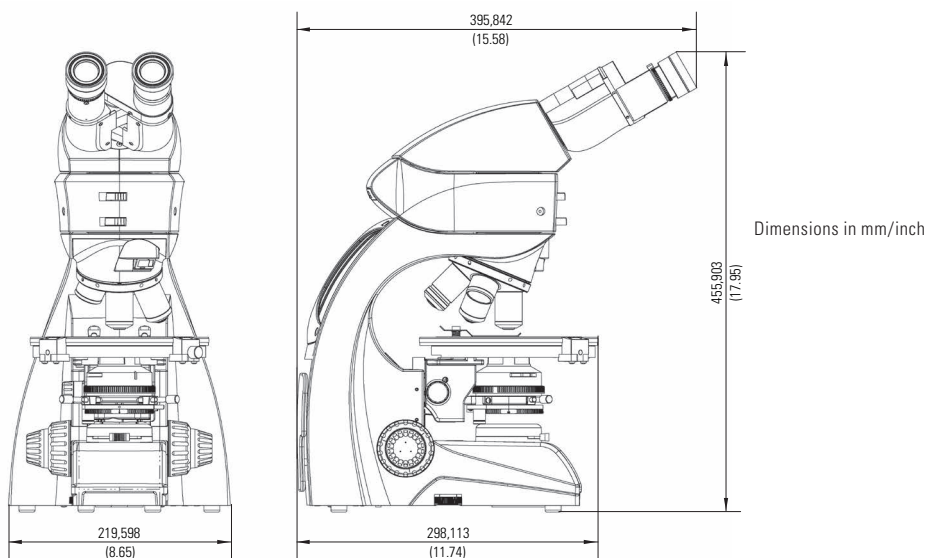

SPECIFICATIONS DM750 P

SEPARATE EYEPIECES

High eyepoint
 10x/20 (20 mm Field of View)
 Crosshair eyepiece with 45° marks, scale, and orientation feature
 Available fixed or focusing
 Focusing eyepieces with reticule holder for 24.5 mm reticule
 Foldable eyeguards
 30 mm mounting diameter

VIEWING TUBES FOR SEPARATE EYEPIECES

30° Pol binocular & trinocular tube with slot for alignment,
 90° and 45° orientation feature on right eyetube for crosshair eyepiece
 Maximum field of view 20 mm
 Leica tube dovetail standard
 Eyepiece locking screw on left eyetube
 Interpupillary distance range 52 mm – 75 mm

STAND

Stand shape protects controls
 Stand construction – die-cast aluminium
 External fuses
 Knurled nosepieces
 4 position centerable nosepieces
 ISO Compensator position above nosepieces
 5 V/1.5 A USB Power Supply to power Camera

EZSTORE™

Vertical handle
 Undercut in front of stand
 Cord wrap
 Vertical cord attachment to stand
 Storage positions in A/B Modules for 2 compensators and objective centering tools
 Magnetic attachment for objective centering tool storage
 Detent attachment for compensator storage

OBJECTIVES

Infinity Platform
 Plan Pol, HI Plan Pol, N Plan Pol
 Objective labeling laser engraved
 M25 nosepiece thread

EZGUIDE™

Point counting and non point counting mechanical stages (stage travel 30 mm × 40 mm)

STAGE

Large 177 mm circular diameter stage surface
 Hard anodized stage surface
 Brake for securing rotation location
 Laser engraved stage calibration in 1 degree increments
 Verniers on two sides to 0.1 degree

CONDENSER

Centerable and focusable condenser mount
 Slot in condenser for contrast sliders (Darkfield, Compensator)
 Magnification labels on condenser
 Standard Leica condenser mount for condensers (Abbe, Turret, Flip top, etc.)

FOCUS

Low position focus controls
 Self adjusting focus mechanism
 300 microns per fine focus rotation
 Calibrated in 3 micron increments
 Weighted focus knobs
 Laser engraved markings

EZLITE™

Available with adjustable Koehler field diaphragm as standard
 LED Illumination – 25,000 hours life
 Continuous intensity adjustment
 Illumination enough for viewing at lowest intensity
 2 hour Auto Off (can be disabled or enabled)

IMAGING

Trinocular tubes available (50 % / 50 % light split)
 C-mount adapters with standard Leica mount

INTERMEDIATE MODULES

15 mm Flat top module

ANALYZER/BERTRAND LENS MODULES

Analyzer module
 Basic A/B module
 Advanced A/B Module with focusing Bertrand Lens

AGTREAT™

Anti microbial treatment

REFLECTED LIGHT AXIS

4-Segment LED illumination for:
 Incident light contrast
 Oblique contrast
 Pol-contrast
 Built-in adjustable aperture diaphragm
 Removable beam splitter to avoid false pleochroism

CERTIFICATIONS

cULus, CE, RoHS
 Main optical components meet ISO 9022-11 for Mould Growth

SHIPPING

Dimensions: 40 cm × 37 cm × 39 cm
 Weight: 9 kg

CLEAN AND GREEN



WE ACTIVELY IMPLEMENT WAYS TO MAKE OUR ENVIRONMENT CLEANER AND SAFER FOR THIS GENERATION AND THE NEXT

- › No lead content in any of the glass components.
- › Constantly optimizing our logistics chain keeps the CO₂ footprint as low as possible.
- › AgTreat™ helps prevent the spread of disease via microscope surfaces and leads to a healthier laboratory environment.
- › All products have been tested by independent safety laboratories and carry the cULus and CE mark to indicate their design for safety.
- › All products are RoHs compliant, which means all electrical components meet restrictions on the use of hazardous substances.

SEE MORE AT WWW.LEICA-MICROSYSTEMS.COM/EDUCATION

- › Interactive tour for Earth and Material Science courses
- › E-Series stereomicroscopes for low magnification inspection, dissecting, and image capture
- › Leica DM500 and Leica DM750 for Life Science Education
- › Selection of higher level microscopes for research
- › A selection of posters and instructional booklets, which are free of charge

CONNECT
WITH US!

